

WASHINGTON 120



Product Features

Hood Mounting	Alfresco Built In (Under Mount)
Cooking Coverage	Suits 100cm - 120cm Cooking Surfaces
Filtration	S-Flow Baffle Filters 3x (H-25) - Dishwasher Safe
Lighting	LED 8x (1.0W)
Finish	AISI316 1.2mm High Grade Stainless Steel
Controls	LED Backlit 4 Button <i>mastermind</i> Electronic Control with LED Speed Indicator with Remote Controller
Speed Settings	3 Speed + Boost Mode
Timer Function	Programmable Timer (10min Increments) + Auto Shut Off After 2Hrs Of Inactivity
Ducting	200mm Acoustic Flexi Ducting - Five (5) Meter Length
Hood Width	1160mm
Hood Depth	480mm
Hood Height	330mm (Plus 25mm Top Outlet)



Filtration Zone



Dimensioned Drawing

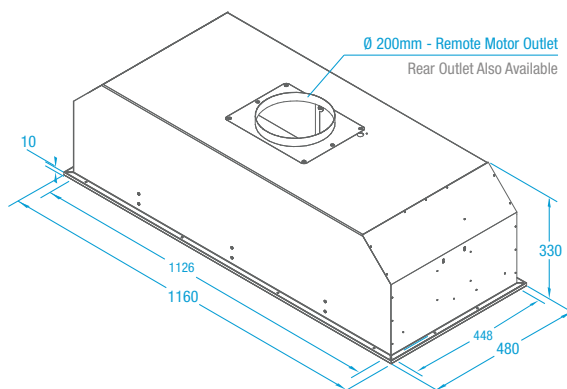

Model / Extraction Unit Selection

X3W12S5.EPP	Alfresco Built In Hood	KleenAir Pro Plus Remote Fan Solution - 2010 m³/hr	Remote External (Roof or Wall Mounted) Motor System
--------------------	------------------------	---	--